



STER



Billboards / Tarpaulins

UNIPLAN E / S	48
UNIPLAN WEDGE	50
UNIMAT V OVERLAP	51
UNIMAT V TAPE	52
TAPEMAT	53
TAPEMAT «Spiegel»	54



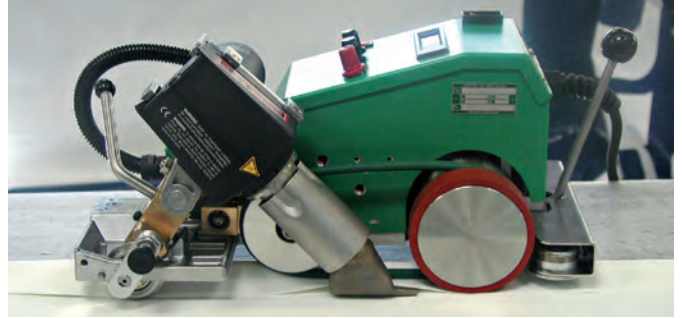

UNIPLAN E, compact and reliable.

Hot air welding machine

UNIPLAN E / UNIPLAN S

The compact precision units with very simple operation.

fig.: UNIPLAN E



1		Automatic start when the hot air element is swung into position.
2		Guide roller for precise welding process (UNIPLAN E).
3		Perfect air stream for 20 mm / 40 mm seams in a extraordinary quality.
4		Air partition for homogenous, wrinkle- free welding seams.
5		Extraction device for changing to next welding seam easily.
6		Automatic control for reproducible welding results (UNIPLAN E).
7		Well-arranged operating unit for all relevant welding parametes like speed, air flow (UNIPLAN E) and temperature.
8	Compact, robust housing for simple, trouble-free handling.	



The handy partner for precise welding:
UNIPLAN E.

Case is included in delivery (weight and weight holder are optional).

Hot air welding machine

UNIPLAN E / UNIPLAN S

UNIPLAN E: Electronically controlled for reproducible results.

UNIPLAN S: For very simple intuitive operation.

- Small, light and handy
- High welding speed
- Reproducible welding results (UNIPLAN E)
- Handy, robust case included in delivery
- Digital display (UNIPLAN E)

Technical Data

Voltage	V~	230
Power consumption	W	2300
Temperature	°C	20 – 620
Speed	m/min	1.0 – 7.5
Air flow range	%	50 – 100 (for UNIPLAN E steplessly)
Welding seam width	mm	20 or 30
Size (L x W x H)	mm	420 x 270 x 210
Weight	kg	11.5 (with 3 m cord)
Marking of conformity		CE
Approval mark		Ⓢ
Certification scheme		CCA
Protection class I		Ⓢ

Article No.

114.221	UNIPLAN E 20 mm, 230V with Euro plug
114.318	UNIPLAN E 30 mm, 230V with Euro plug
115.049	UNIPLAN S 20 mm, 230V with Euro plug
115.050	UNIPLAN S 30 mm, 230V with Euro plug

Other versions on request

Accessories UNIPLAN E / UNIPLAN S

115.065 115.066		Overlap welding unit 20 mm Overlap welding unit 30 mm
115.067		Weight with holder
115.839		Handle with holder and screws
119.933 119.934		Hem welding kit 20 mm Hem welding kit 30 mm
122.013 122.016		Hem cord welding kit with lifting device until end of 2003 Hem cord welding kit without lifting device from 2004
122.022		Guide bar complete
116.798		Brass brush to clean nozzle
103.604 101.910		Heating element, 230 V / 2100 W for UNIPLAN E Heating element, 230 V / 2100 W for UNIPLAN S
126.448		Sturdy storage case* 605 x 486 x 312 mm multi-layer plate, green * included in delivery



For accurately fitting weld seams of billboards.

Billboards from all over the world.

Wedge welding machine

UNIPLAN WEDGE

The noiseless UNIPLAN WEDGE is the perfect machine for all critical materials. The innovative laser guide guarantees a flawless welding.

- Low noise
- High welding speed
- Portable and light
- Easy, comfortable operation
- Digital display of welding speed and temperature

Technical Data





Voltage	V~	230
Power consumption	W	900
Frequency	Hz	50 / 60
Temperature	°C	20 – 420
Speed	m/min	1.0 – 7.5
Noise emission level L_{pA}	dB	50
Welding seam width	mm	20 or 30
Size (L x W x H)	mm	420 x 270 x 210
Weight	kg	11.5 (with 3 m cord)
Marking of conformity		CE
Approval mark		Ⓢ
Certification scheme		CCA
Protection class I		Ⓢ

Article No.

- 116.972 UNIPLAN Wedge 20 mm, Laserguide, 230V with Euro plug
 116.975 UNIPLAN Wedge 30 mm, Laserguide, 230V with Euro plug

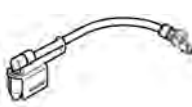
Other versions on request

Accessories UNIPLAN WEDGE

127.992 127.989		Hot-wedge 20 mm, 230 V~ Hot-wedge 30 mm, 230 V~
116.506		One-arm pressure roller 40 mm, with ball bearings (silicon)
116.231		Trolley attachment for acrylic tape
116.798		Brass brush to clean nozzle
126.448		Sturdy storage case* 605 x 486 x 312 mm multi-layer plate, green * included in delivery



Processing truck covers and tarpaulins with the UNIMAT V OVERLAP.



Suitable for rapid welding of large billboards.





Hot air welding machine

UNIMAT V OVERLAP

Extremely fast 20/40 mm overlap welding of industrial fabrics and banners.

- High welding speed
- Digital display of set and actual values of welding speed, temperature and air flow
- No corrective action required thanks to the new guide roller
- Automatic start
- Integrated lifting mechanism

Accessories UNIMAT V OVERLAP

128.098 128.099		Hem cord kit 20 mm Hem cord kit 40 mm
114.510 114.498		Overlap welding nozzle 20 mm Overlap welding nozzle 40 mm
115.014 115.015		Retrofit kit for tape welding 40 mm Retrofit kit for tape welding 50 mm
114.418		Heating element 230 V / 2 x1800 W

Technical Data

Voltage	V~	230
Power consumption	W	3680
Temperature	°C	20 – 620
Speed	m/min	1.5 – 12
Air flow range	%	50 – 100 (steplessly)
Welding seam / tape width	mm	20 or 40
Size (L x W x H)	mm	600 x 430 x 310
Weight	kg	23.0 (with 5 m cord)
Marking of conformity		CE
Approval mark		Ⓢ
Certification scheme		CCA
Protection class I		Ⓢ

Article No.

- 119.095 UNIMAT V OVERLAP 20 mm, 230V with Euro plug
119.094 UNIMAT V OVERLAP 40 mm, 230V with Euro plug

Other versions on request



Optimised for tapes of 40 mm and 50 mm.

To weld tapes for side curtains.

Hot air welding machine

UNIMAT V TAPE

Accurate welding of belts and tapes.

- High welding speed
- Digital display of set and actual values of welding speed, temperature and air flow
- No corrective action required thanks to the new guide roller
- Automatic start
- Integrated lifting mechanism

Accessories UNIMAT V TAPE

115.184		Retrofit kit from tape to overlap welding 20 mm
115.185		Retrofit kit from tape to overlap welding 40 mm
115.192		Tape welding unit 40 mm to convert 50 mm tape to 40 mm tape
115.193		Tape welding unit mm to convert 40 mm tape to 50 mm tape
114.418		Heating element 230 V / 2 x 1800 W

Technical Data

Voltage	V~	230
Power consumption	W	3680
Temperature	°C	20 – 620
Speed	m/min	1.5 – 12
Air flow range	%	50 – 100 (steplessly)
Welding seam / tape width	mm	40 or 50
Size (L x W x H)	mm	600 x 415 x 310
Weight	kg	28.0 (with 5 m cord)
Marking of conformity		CE
Approval mark		Ⓢ
Certification scheme		CCA
Protection class I		⊕

Article No.

- 119.097 UNIMAT V TAPE 40 mm, 230V with Euro plug
 119.096 UNIMAT V TAPE 50 mm, 230V with Euro plug

Other versions on request



Welding tapes at maximum speed.



Art project in Basel, Switzerland.



Tape welding machine

TAPEMAT

The powerful package for rapid economical strip welding of lorry covers and industrial curtains. Very fast strip welder at up to 20 m/min.

- High welding speed
- Process-optimized nozzle
- Maintenance-free, brushless blower
- Intuitive operation and simple handling
- Constant tape tension

Accessories TAPEMAT

138.242		Lifting device
131.690		Welding nozzle complete, 50 mm
101.991		Heating element 3 x 400 V / 3 x 3300 W

Technical Data

Voltage	V~	3 x 400
Power consumption	kW	10
Frequency	Hz	50/60
Temperature	°C	ca. 700
Maximal speed	m/min	20
Welding seam width	mm	50
Size (L x W x H)	mm	555 x 435 x 370
Weight	kg	40
Marking of conformity		CE
Approval mark		Ⓢ
Certification scheme		CCA
Protection class I		Ⓛ

Article No.

129.757 TAPEMAT 50 mm 400V, with 16A CEE plug

Other versions on request



Tarpaulin bows for fixed and sliding rooftops of lorries (Pictures: Krone).



Intuitive operation and simple handling.





«Spiegel» welding machine

TAPEMAT «Spiegel»

The power pack for fast and economic welding of tarpaulin bows for lorries. With its top speed of up to 20 m/min it is a very fast tarpaulin bow welding machine. The TAPEMAT «Spiegel», an investment, which already pays off after shortest time!

- Top welding speed
- Process-optimized high-precision nozzle
- Maintenance-free, brushless blower
- Easy to exchange counter-pressure roller
- Constant tarpaulin bow tension

Accessories TAPEMAT «Spiegel»

138.242		Lifting device
137.412		Welding nozzle complete, 100 mm
135.392		Welding nozzle complete, 125 mm
101.991		Heating element, 3 x 400 V / 3 x 3300 W

Technical Data

Voltage	V~	3 x 400
Power consumption	kW	10
Frequency	Hz	50/60
Temperature	°C	ca. 700
Maximal speed	m/min	20
Welding seam width	mm	50
Size (L x W x H)	mm	555 x 435 x 370
Weight	kg	40
Marking of conformity		CE
Approval mark		Ⓢ
Certification scheme		CCA
Protection class I		Ⓢ

Article No.

- 138.229 TAPEMAT Spiegel 100 mm, 400V with 16A CEE plug
 133.597 TAPEMAT Spiegel 125 mm, 400V with 16A CEE plug



Hand tool

TRIAC PID

Closed loop control of temperature and monitoring of functions thanks to micro processor. The popular hand tool for top quality results.

- Reproducible results thanks to digital display of set and actual values of temperature.
- Constant temperature independent of voltage fluctuations and environmental conditions.
- Adaptor tube with heat protection
- Electronic protection of heating element
- Motor shut-off at minimal carbon level

Technical Data

Voltage	V~	230 / 120
Power	W	1600
Frequency	Hz	50 / 60
Temperature	°C	50 – 600
Size (L x Ø)	mm	340 x 90, handle Ø 56
Weight	kg	1.1 (without 3 m cord)
Marking of conformity	CE	
Approval Mark	S	
Certification Scheme	CCA	
Protection Class II	□	

Artikel-Nr.

- 100.741 TRIAC PID 230V / 1600W for snap-fit nozzles with Euro plug
 100.742 TRIAC PID 230V / 1600W for screw-on nozzles with Euro plug
 111.165 TRIAC PID 120V / 1600W for snap-fit nozzles with UK plug

Hand tool

TRIAC S

The reliable, cost-effective and proven hand tool with stepless adjustment of temperature range.

- Adaptor tube with heat protection
- Electronic protection of heating element
- Motor shut-off at minimal carbon level
- Multiple replacement of carbon brushes possible
- Suitable for continuous operation

Technical Data

Voltage	V~	230
Power	W	1600
Frequency	Hz	50 / 60
Temperature	°C	20 – 700
Size (L x Ø)	mm	340 x 90, handle Ø 56
Weight	kg	1.1 (without 3 m cord)
Marking of conformity	CE	
Approval Mark	S	
Certification Scheme	CCA	
Protection Class II	□	

Artikel-Nr.

- 100.705 TRIAC S 230V / 1600W for snap-fit nozzles with Euro plug
 100.706 TRIAC S 230V / 1600W for screw-on nozzles with Euro plug
 100.709 TRIAC S 230V / 1600W for snap-fit nozzles with Australian plug
 112.230 TRIAC S 230V / 1600W for snap-fit nozzles with UK plug black
 109.987 TRIAC S 120V / 1600W for snap-fit nozzles with UK plug yellow



Working with the reliable TRIAC, the specialist produces perfect welding results.



Welding of the connectors with TRIAC PID and push-fit wide slot nozzle.



The handy transport box provides ample room for the required equipment.

Accessories TRIAC PID / TRIAC S

Roofing

107.124		Angled nozzle 20 mm, 90°, push-fit
107.125		Angled nozzle 20 mm, 60°, push-fit
107.132 107.130 107.133 128.535		Wide slot nozzle, push-fit, 40 mm 40 mm, 60° bent 40 mm, perforated 30 mm, 45° bent
107.129		Wide slot nozzle 60 mm for bitumen, push-fit
107.131		Wide slot nozzle 80 mm, push-fit
107.123		Wide slot nozzle 20 mm, push-fit
100.303 105.578		Tubular nozzle \varnothing 5 mm, push-fit Version extra strong
106.989		Speed weld nozzle 3 mm, push-fit on tubular nozzle \varnothing 5 mm
106.990		Speed weld nozzle 4 mm, push-fit on tubular nozzle \varnothing 5 mm
106.991		Speed weld nozzle 5 mm, push-fit on tubular nozzle \varnothing 5 mm
100.296		Heating element, 230 V, 1550 W, for TRIAC PID
100.689		Heating element, 230 V, 1550 W, for TRIAC S

Billboards / Tarpaulins

107.123		Wide slot nozzle 20 mm, angled, push-fit
105.487		Wide slot nozzle 20 mm, bent and angled, push-fit

107.132 107.130 107.133 128.535		Wide slot nozzle, push-fit 40 mm 40 mm, 60° bent 40 mm, perforated 30 mm, 45° bent
107.124		Angled nozzle 20 mm, 90°, push-fit
107.125		Angled nozzle 20 mm, 60°, push-fit
105.492		Wide slot nozzle 20 mm, straight jaw, 120° bent at right angle
100.296		Heating element, 230 V, 1550 W, for TRIAC PID
100.689		Heating element, 230 V, 1550 W, for TRIAC S





Civil Engineering / Tunnel / Landfill sites

107.123		Wide slot nozzle 20 mm, push-fit
107.132		Wide slot nozzle 40 mm, push-fit
107.135		Wide slot nozzle 40 mm, PTFE-coated, push-fit
100.296		Heating element, 230 V / 1550 W, for TRIAC PID
100.650		Heating element, 120 V / 1600 W, for TRIAC PID
100.689		Heating element, 230 V / 1550 W, for TRIAC S
100.702		Heating element, 120 V / 1550 W, for TRIAC S



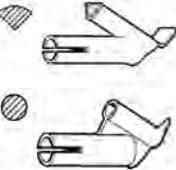

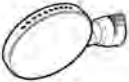

The professional Handtool for work on the roof.

Apparatus and container construction (with push-fit nozzle)

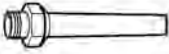

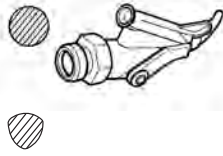

100.303 105.578		Tubular nozzle \varnothing 5 mm, for versions with nozzles, push-fit Version extra-strong
106.992 106.993 106.989 106.990 106.991		Speed weld nozzle, push-fit on tubular nozzle \varnothing 5 mm 5.7 mm, profile A 7 mm, profile B 3 mm 4 mm 5 mm
106.996		Tacking nozzle, push-fit on tubular nozzle \varnothing 5 mm
107.348		Device rest
107.344		Welding mirror 135 mm, push-fit
100.296 100.689		Heating element, 230 V, 1550 W, for TRIAC PID Heating element, 230 V, 1550 W, for TRIAC S

Apparatus and container construction (with screw-on nozzle)

105.622		Tubular nozzle, \varnothing 5 mm, screw-on
106.988		Tacking nozzle, screw-on
113.666 113.399 113.876 113.874		drawing nozzle, \varnothing 3 mm drawing nozzle, \varnothing 4 mm, with tacking tip, screw-on drawing nozzle, \varnothing 3 mm drawing nozzle, \varnothing 4 mm, without tacking tip, screw-on

113.670 113.877 106.986 106.987		drawing nozzle triangular shaped, with tacking tip, screw-on, 90 – 5.7 mm drawing nozzle triangular shaped, without tacking tip, screw-on 5.7 mm, profile A 7 mm, profile B 7 x 5.5 mm
126.552		drawing nozzle \varnothing 4 mm, screw-on for fluor plastics

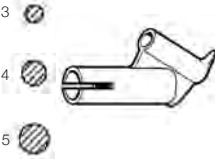
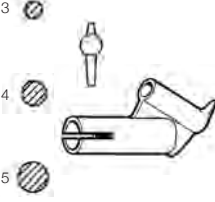
Floors / Interior Design

100.303 105.578		Tubular nozzle \varnothing 5 mm, for versions with nozzles, push-fit Version extra-strong
106.982		Extension nozzle \varnothing 5 mm, 150 mm
106.989 106.990 106.991		Speed weld nozzle 3 mm, push-fit on Tubular nozzle \varnothing 5 mm Speed weld nozzle 4 mm, push-fit on Tubular nozzle \varnothing 5 mm Speed weld nozzle 5 mm, push-fit on Tubular nozzle \varnothing 5 mm
105.431 105.432 105.433		Speed weld nozzle 3 mm, with small air-slide, push-fit on Tubular nozzle \varnothing 5 mm Speed weld nozzle 4 mm, with small air-slide, push-fit on Tubular nozzle \varnothing 5 mm Speed weld nozzle 5 mm, with small air-slide, push-fit on Tubular nozzle \varnothing 5 mm
107.139		Speed weld nozzle 4.5 x 12 mm for fillet weld, push-fit on Tubular nozzle \varnothing 5 mm





The TRIAC S hand welding tool, used for welding linoleum, equipped with a speed weld nozzle.



TRIAC PID: monitoring of welding temperature for top quality.







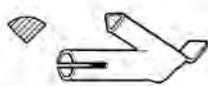

Welding a patch with the TRIAC PID on a building site.

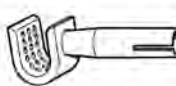
107.137		Speed weld nozzle for tape welding 8 mm, push-fit on Tubular nozzle Ø 5 mm
100.296 100.689		Heating element, 230 V, 1550 W, for TRIAC PID Heating element, 230 V, 1550 W, for TRIAC S

106.997		Rotary burr Ø 6 mm (for drilling machine)
106.992		Speed weld nozzle 5.7 mm, push-fit on tubular nozzle Ø 5 mm

Shrinking and vehicle repairs

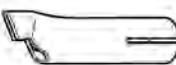
107.324		sieve reflector 12 x 10 mm, push-fit on Tubular nozzle Ø 5 mm
107.337		sieve reflector 50 x 35 mm, push-fit
107.338		sieve reflector 35 x 20 mm, push-fit
107.326		Shell reflector 25 x 150 mm, push-fit
107.307		Spoon reflector 27 x 35 mm, push-fit
107.339		Soldering reflector 17 x 34 mm, push-fit
106.996		Tacking nozzle, push-fit on tubular nozzle Ø 5 mm

Other versions on request.
Technical data are subject to change without prior notice.



Well balanced design for precise welding.

Hand tool

TRIAC BT

The TRIAC BT fulfills all of the functionality and design requirements necessary for successful plastic welding. Weighing just one kilogram, it is the lightest in its class and is made from high-quality material. Every TRIAC BT kit undergoes stringent quality checks before leaving the factory in Switzerland. The sturdy tool box includes everything an expert technician requires.

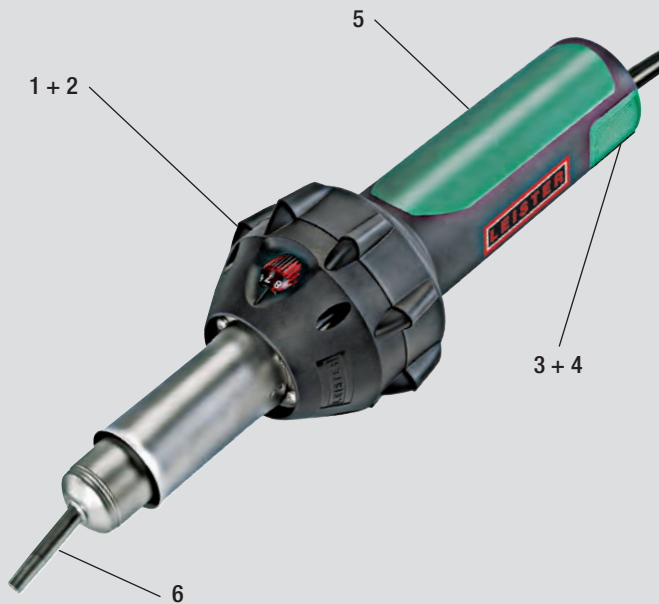

1		<p>Temperature setting: Convenient and reliable temperature adjustment</p>
2		<p>Accidental start-up protection: The temperature adjustment becomes lit-up if the power to the tool is interrupted</p>
3		<p>Filter: The fine mesh air filter prevents dirt from clogging the air inlet of the tool</p>
4		<p>Filter cleaning: The air filters on both sides can be easily removed and cleaned</p>
5		<p>Tool handle: Ergonomically designed handle with soft grip covering for a secure hold</p>
6		<p>Nozzle: Extra strong integral 5 mm universal nozzle</p>
7		<p>Spare heating element: Protected, packed in a box and within easy reach</p>
8		<p>Tool box: Enough space for all the accessories the professional needs</p>



Contained in delivery



Intuitive design and easy handling for precision welding.



Perfect for detailed work.

Hand tool

TRIAC BT tarpaulin welding-set

The TRIAC BT tarpaulin welding-set is the perfect set for the ambitious tarpaulin specialist.

- Light and easy to handle
- Ergonomic handle for welding without strain
- Electronically protected heating element
- Integral precision nozzle
- Built in start-up protection in case of power interruption

Accessories TRIAC BT

140.160		Pressure roller 40 mm with ball bearings, (Silicone)
140.161		Pressure roller 28 mm with ball bearings, (Silicone)
136.916		Heating element, 230 V / 1550 W
116.586		Tool box, for TRIAC BT, TRIAC PID, TRIAC S, ELECTRON
137.855		Leister-Cutter with 4 spare blades

Technical Data

Voltage	V~	230
Power	W	1600
Temperature	°C	20 – 700
Size (L x Ø)	mm	370 x 90, handle Ø 56
Weight	kg	1.0 (without 2 m cord)
Marking of conformity	CE	
Approval Mark	Ⓢ	
Certification Scheme	CCA, CB	
Protection Class II	□	

Article No.

- 136.937 TRIAC BT 230V / 1600W tarpaulin kit 20mm with Euro-plug
 136.938 TRIAC BT 230V / 1600W tarpaulin kit 40mm with Euro-plug

Within scope of supply: Transport box, spare heating element, pressure roller 40 mm



Contained in delivery

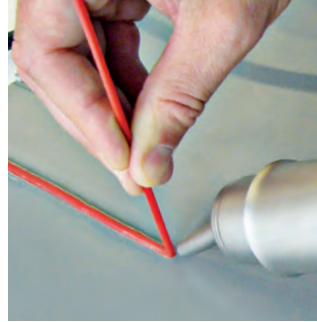

Perfect for hot gas extrusion welding of containers and apparatuses

Hand tool

TRIAC BT plastic welding kit

Das TRIAC BT Plastic welding kit is the perfect kit for the ambitious container and apparatus engineers.

- Light and easy to handle
- Ergonomic handle for welding without strain
- Electronically protected heating element
- Integral universal nozzle
- Built in start-up protection in case of power interruption

Technical Data







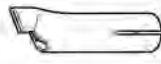

Voltage	V~	230
Power	W	1600
Temperature	°C	20 – 700
Size (L × Ø)	mm	370 × 90, handle Ø 56
Weight	kg	1.0 (without 2 m cord)
Marking of conformity	CE	
Approval Mark	Ⓢ	
Certification Scheme	CCA, CB	
Protection Class II	□	

Article No.

136.939 TRIAC BT 230V / 1600W plastic welding kit with Euro-plug

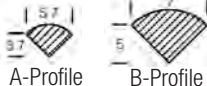
Included in delivery: TRIAC BT, tool box, spare heating element, tacking nozzle and speed welding nozzle 5.7 mm (profile A)

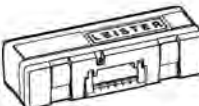
Accessories TRIAC BT

106.996		Tacking nozzle, push fit
106.989	3 	Speed weld nozzle, push-fit (3 mm)
106.990	4 	Speed weld nozzle, push-fit (4 mm)
106.991	5 	Speed weld nozzle, push-fit (5 mm)
106.992		Speed weld nozzle, push-fit (5.7 mm, A)
106.993		Speed weld nozzle, push-fit (7 mm, B)
136.916		Heating element, 230 V / 1550 W
116.586		Tool box, for TRIAC BT, TRIAC PID, TRIAC S, ELECTRON
137.855		Leister-Cutter with 4 spare blades



Contained in delivery



Well balanced design for precise welding of floor coverings.

Hand tool

TRIAC BT floor welding kit

The TRIAC BT floor welding kit is the ideal kit for the ambitious flooring technician.

- Light and easy to handle
- Ergonomic handle for welding without strain
- Electronically protected heating element
- Integral universal nozzle
- Built in start-up protection in case of power interruption

Technical Data

Voltage	V~	230
Power	W	1600
Temperature	°C	20 – 700
Size (L x Ø)	mm	370 x 90, handle Ø 56
Weight	kg	1.0 (without 2 m cord)
Marking of conformity	CE	
Approval Mark	S	
Certification Scheme	CCA, CB	
Protection Class II	□	

Article No.

136.936 TRIAC BT 230V / 1600W floor welding kit with Euro-plug

Included in delivery: TRIAC BT, transport box, spare heating element, Speed weld nozzle 5 mm and speed weld nozzle with small air-slide

Accessories TRIAC BT

107.139		Speed weld nozzle, push-fit (4.5 x 12 mm)
106.989	3	Speed weld nozzle, push-fit (3 mm)
106.990	4	Speed weld nozzle, push-fit (4 mm)
106.991	5	Speed weld nozzle, push-fit (5 mm)
105.431	3	Speed weld nozzle, with small air-slide, push-fit (3 mm)
105.432	4	Speed weld nozzle, with small air-slide, push-fit (4 mm)
105.433	5	Speed weld nozzle, with small air-slide, push-fit (5 mm)
136.916		Heating element, 230 V / 1550 W
116.586		Tool box, for TRIAC BT, TRIAC PID, TRIAC S, ELECTRON
137.855		Leister-Cutter with 4 spare blades



Hand tool

HOT JET S

As the most compact hand tool from Leister, the HOT JET S' low weight of 600 g, incl. cord and slim handle, ensures fatigue-free welding and high power.

- The smallest Leister hand tool
- Electronic steplessly controlled temperature
- Electronic steplessly controlled air flow
- Low noise
- Integrated flexible tool stand

Technical Data

Voltage	V~	230
Power	W	460
Frequency	Hz	50 / 60
Temperature	°C	20 – 600
Pressure static	Pa	max. 1600 (16 mbar)
Size (L x Ø)	mm	235 x 70, handle Ø 40
Weight	kg	0.4 (without 3 m cord)
Marking of conformity		CE
Approval Mark		Ⓢ
Certification Scheme		CCA
Protection Class II		□

Artikel-Nr.

- 100.648 HOT JET S 230V / 460W with Euro plug
- 112.229 HOT JET S 230V / 460W with UK plug black
- 100.854 HOT JET S 230V / 460W with AUS plug
- 100.861 HOT JET S 120V / 460W with USA plug

Accessories HOT JET S

107.141		Wide slot nozzle 15 mm, push-fit
107.142		Wide slot nozzle 20 mm, push-fit
107.144		Tubular nozzle Ø 5 mm, push-fit
105.567		Extension nozzle Ø 5 x 150 mm, straight
105.556		Angled nozzle 20 mm, 90° angled, push-fit
106.996		Tacking nozzle, push-fit on Tubular nozzle Ø 5 mm
106.989		Speed weld nozzle 3 mm, push-fit on Tubular nozzle Ø 5 mm
106.990		Speed weld nozzle 4 mm, push-fit on Tubular nozzle Ø 5 mm
106.991		Speed weld nozzle 5 mm, push-fit on Tubular nozzle Ø 5 mm
106.992		Speed weld nozzle, push-fit (5.7 mm, A)
106.993		Speed weld nozzle, push-fit (7 mm, B)
105.431		Speed weld nozzle 3 mm, with small air-slide, push-fit on Tubular nozzle Ø 5 mm
105.432		Speed weld nozzle 4 mm, with small air-slide, push-fit on Tubular nozzle Ø 5 mm
105.433		Speed weld nozzle 5 mm, with small air-slide, push-fit on Tubular nozzle Ø 5 mm













Fitting a solder shrink connection with HOT JET S and a push-fit sieve reflector.

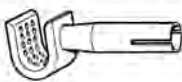

The HOT JET S is especially suited to carry out work in areas which are difficult to access.



The small and light HOT JET S is especially suited to carry out work where space is tight.

107.137		Speed weld nozzle for tape welding 8 mm, push-fit on Tubular nozzle Ø 5 mm	107.305		Ironing nozzle 15 x 25 mm
107.139		Speed weld nozzle 4.5 x 12 mm for fillet weld, push-fit on Tubular nozzle Ø 5 mm	100.818		Heating element, 230 V / 435 W
107.324		Sieve reflector 12 x 10 mm, push-fit on Tubular nozzle Ø 5 mm			
107.146		Soldering nozzle Ø 2 mm			
107.151		Soldering nozzle Ø 4 mm			
107.148		Soldering nozzle Ø 3 x 1.5 mm, oval			
107.310		Sieve reflector 35 x 20 mm, push-fit			
107.311		Sieve reflector 50 x 35 mm, push-fit			
107.312		Spoon reflector 25 x 30 mm, push-fit			



Simple heating up fibre optic loose tube cables for further processing.



Welding pipes

Hand tool

GIBLI

Derived from a hot desert wind – GIBLI certainly lives up to its name! Thanks to two-step airflow switching and steplessly adjustable temperature, it can be used for the most diverse applications.

- Universal tool for welding and shrinking
- Welding results independent of voltage fluctuations and ambient temperature
- Two-step selectable air flow
- Extensive range of accessories

Technical Data

Voltage	V~	230
Power	W	2000
Frequency	Hz	50 / 60
Temperature	°C	20 – 600
Pressure static	Pa	Stufe 2: 1500 (15 mbar) Stufe 3: 2100 (21 mbar)
Size (L × B × H)	mm	195 × 85 × 160, handle Ø 57
Weight	kg	0.9 (without 3 m cord)
Marking of conformity		CE
Approval Mark		Ⓢ
Certification Scheme		CCA
Protection Class II		□

Article No.

- 101.881 GIBLI 230V / 2000W with Euro plug
101.887 GIBLI 120V / 1500W with USA plug

More versions on request

Accessories GIBLI

106.998		Wide slot nozzle 20 mm, push-fit
106.999		Wide slot nozzle 40 mm
107.154		Tubular nozzle Ø 5 mm, push-fit
107.006		Extension nozzle Ø 5 x 130 mm, straight
107.308		Sieve reflector 50 × 35 mm, push-fit
107.309		Sieve reflector 35 × 20 mm, push-fit
107.313		Spoon reflector 25 × 30 mm, push-fit
107.325		Soldering reflector 17 × 34 mm, push-fit
107.319		Sieve reflector Ø 65 mm
107.315		Folding reflector 70 × 12 mm, push-fit
107.007		De-horning nozzle
107.345		Welding mirror 135 mm, PTFE-coated
115.513		Heating element, 230 V / 1800 W



Contained in delivery



Shrinking of cable labels



Ergonomic design for strain-free car wrapping.

Hand tool

SONORA S1

The handy, quiet and compact tool for universal use. It is applied in fields as diverse as shrinking, vehicle labeling, forming and heating. Its balanced design allows for strain-free welding. Excellent price/performance ratio.

- Light and compact
- High stability in head-handle position for long term use
- Balanced ergonomics with soft grip
- Very quiet tool, ideal for indoor use
- Constant temperature and closed-loop controlled electronics

Technical Data







Voltage	V	230
Power	W	2000
Temperature	°C	80 – 650
Size	mm	230 x 200
Weight	kg	0.6 (without 2 m cord)

Article No.

140.996 SONORA S1, 230 V / 2000 W with Euro-plug

More versions on request

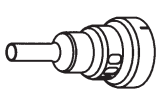
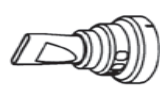
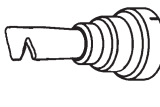
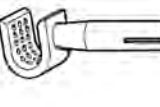
Accessories SONORA S1

119.269		Glass protection nozzle
119.270		Wide slot nozzle 50 mm
119.314		Reducer nozzle (Included in delivery)
119.271		Reflector nozzle (Included in delivery)
119.316		Tubular nozzle 5 mm
119.315		Wide slot nozzle 20 mm
119.312		Solder sleeve reflector nozzle (Included in delivery)
107.324		sieve reflector 12 x 10 mm
107.308		sieve reflector 50 x 35 mm



Welding of bitumen sheeting using the powerful ELECTRON with a wide slot nozzle.

Hand tool

ELECTRON

Powerful and versatile, the ELECTRON is the tool the specialist would wish for.

- Powerful
- Compact
- Robust
- Construction site tried and tested

Technical Data

Voltage	V~	230 / 400
Power	W	3400 / 5500
Frequency	Hz	50 / 60
Temperature	°C	20 – 650
Pressure static	Pa	3000 (30 mbar)
Size (L x Ø)	mm	320 x 95, handle Ø 64
Weight	kg	1.3 (without 3 m cord)
Marking of conformity	CE	
Approval Mark	Ⓢ	
Certification Scheme	CCA	
Protection Class II	□	

Article No.

107.781	ELECTRON 230V / 3400W with Euro plug
107.788	ELECTRON 400V / 5500W, with 16A CEE-Stecker
110.889	ELECTRON 120V / 2700W with 32A UK plug
116.055	ELECTRON 230V / 3400W with sprap nozzle, with Euro plug

More versions on request

Accessories ELECTRON









107.258		Wide slot nozzle, push-fit 70 x 10 mm, for bitumen
107.134		Wide slot nozzle, push-fit 40 x 2 mm, for bitumen
107.266		Wide slot nozzle 75 x 2 mm, push-fit, with tool stand (Artikel 116.753)
116.753		Tool stand
107.270		Wide slot nozzle 150 x 12 mm, push-fit
107.229		Round nozzle 20 mm
107.331		Folding reflector 70 x 70 mm, push-fit
107.327		Sieve reflector 85 x 85 mm, push-fit
107.333		Sieve reflector 150 x 130 mm, push-fit
107.340		Shell reflector, 45 x 250 mm, push-fit
107.328		Folding reflector 60 x 75 mm, push-fit

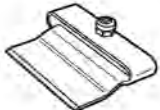

Accelerating the drying process of varnish, paint and body filler using the ELECTRON.



ELECTRON with scraper nozzle. Scraping color without solvent!

106.127		Sieve reflector Ø 65 mm
107.330		Folding reflector 125 x 22 mm, push-fit
116.054		Scraper nozzle, (only use in combination with heater tube, Article no. 116.053)
105.961		Wide slot nozzle 45 x 12 x 350 mm (for foundries)
107.347		Swordshaped nozzle 74 x 12 x 520 mm, edges rounded, PTFE-coated
107.346		Welding mirror 270 mm, push-fit
107.348		Tool rest
113.269		Heating element, 230 V / 3400 W
101.273		Heating element, 400 V / 5500 W



Hand tools

General Accessories

Roofing

140.160		Pressure roller 40 mm with ball bearings, (Silicone)
140.161		Pressure roller 28 mm with ball bearings, (Silicone)
106.974		Pressure roller 80 mm (Silicone)
106.972		Pressure roller 80 mm (Silicone)
106.976		Pressure roller 28 mm (PTFE)
138.314		Seam probe tester
111.346		Edge plane with 10 spare blades
111.348		spare blades kit containing 10 blades
137.855		Leister-Cutter with 4 spare blades
116.586		Transport box, for TRIAC BT, TRIAC PID, TRIAC S, ELECTRON

Billboards / Tarpaulins

106.974		Pressure roller 80 mm (Silicone)
---------	--	----------------------------------





140.160		Pressure roller 40 mm with ball bearings, (Silicone)
140.161		Pressure roller 28 mm with ball bearings, (Silicone)
106.981		Pressure roller for customs seal roller
137.855		Leister-Cutter with 4 spare blades
116.586		Transport box, for TRIAC BT, TRIAC PID, TRIAC S, ELECTRON
116.798		Brass brush

Civil Engineering / Tunnel / Landfill sites

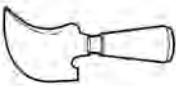

140.160		Pressure roller 40 mm with ball bearings, (Silicone)
140.161		Pressure roller 28 mm with ball bearings, (Silicone)
106.976		Pressure roller 28 mm (PTFE)

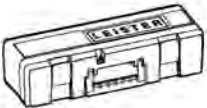

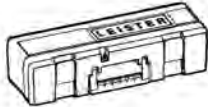
Container and apparatus construction

107.348		Tool rest (TRIAC)	106.969		Spatula
137.855		Leister-Cutter with 4 spare blades	137.855		Leister-Cutter with 4 spare blades
116.586		Transport box, for TRIAC BT, TRIAC PID, TRIAC S, ELECTRON	106.966		Hand grooving tool
			106.968		Spare blades for hand grooving tool
			116.586		Transport box, for TRIAC BT, TRIAC PID, TRIAC S, ELECTRON

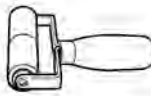
Floorings / Interior decoration

122.541		Trimming guide
106.972		Pressure roller, with ball bearings (Brass)
106.974		Pressure roller 80 mm (silicone)
140.160		Pressure roller 40 mm with ball bearings, (Silicone)
140.161		Pressure roller 28 mm with ball bearings, (Silicone)
106.976		Pressure roller 28 mm (PTFE)